



Sensor Master by Trafag AG

Technical specification

Mounting torque:	15 ... 20 Nm
Operating temperature:	-25°C ... +85°C
Media temperature:	-25°C ... +85°C
Protection:	IP67
Display pressure unit:	bar, psi, MPa, kPa, m WC, mm WC
Switching current:	Max. 0.5 A per switching output
Parametrisation:	With 3 buttons and menu navigation or via NFC - Smartphone App

Type label description

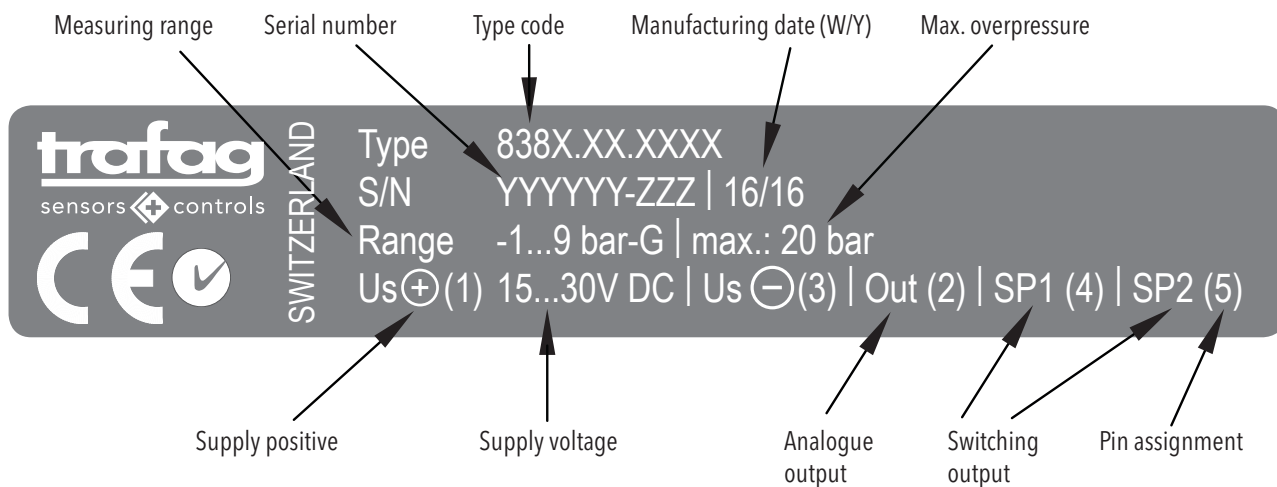

Electrical connection

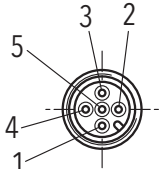
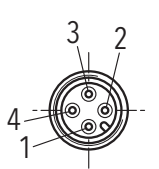
Ingress Protection	IP67*)	IP67*)
Designation	M12x1 5-pole	M12x1 4-pole
Type code	838X.XX.XXXX 35	838X.XX.XXXX 32
Pin configuration		

*) Provided female connector is mounted according to instructions

Output signal / supply voltage

Output	I _{SUPPLY}	U _{SUPPLY}
4 ... 20 mA	≤ 30 mA	15 ... 30 VDC
0 ... 10 VDC	≤ 30 mA	15 ... 30 VDC
0 ... 5 VDC	≤ 30 mA	15 ... 30 VDC
1 ... 6 VDC	≤ 30 mA	15 ... 30 VDC

Connection of the measuring equipment

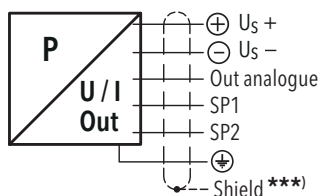

***) The use of a shielded cable is recommended

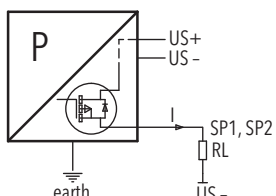

Connection of loads to switching output

4...20mA: min./max resistor vs. supply voltage @ Pmax = 100%

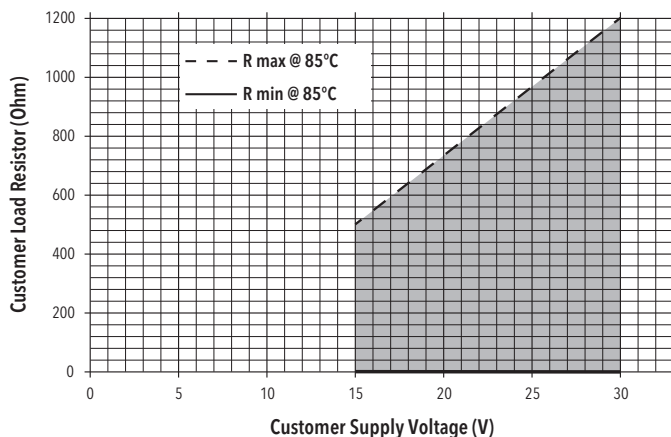

Mounting

Tighten the device

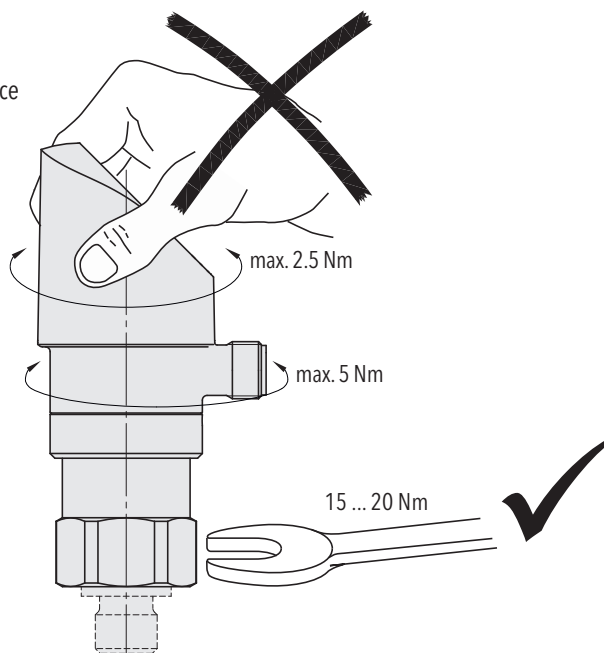

Switching output functions

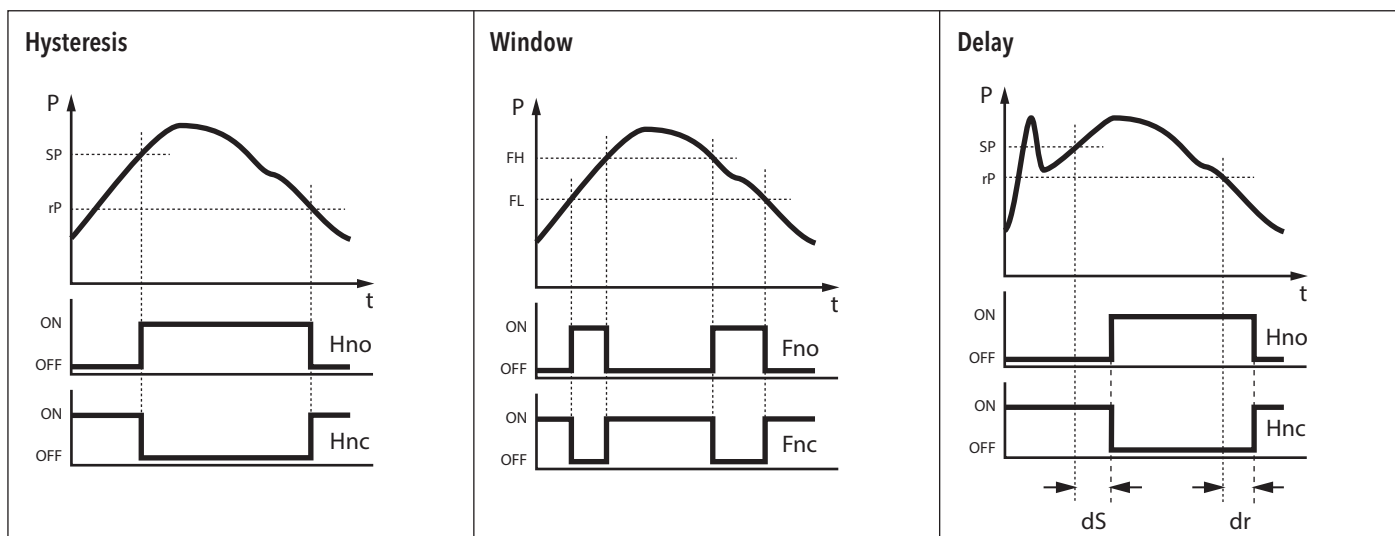

Dimensions

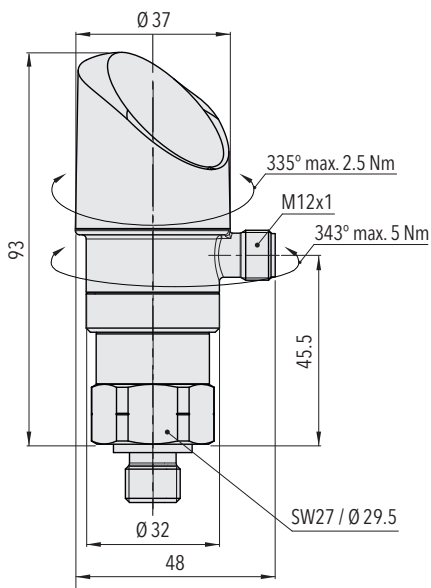

Protective cap

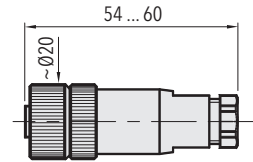
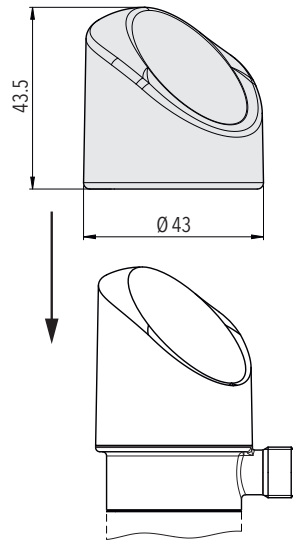

838X.XX.XXXX.35/32.XX.XX

838X.XX.XXXX.XX.XX.33

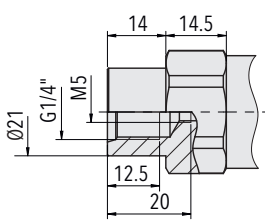

838X.XX.XX10.XX.XX.XX

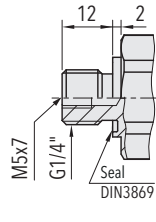

838X.XX.XX17.XX.XX.XX

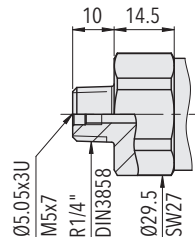

838X.XX.XX19.XX.XX.XX

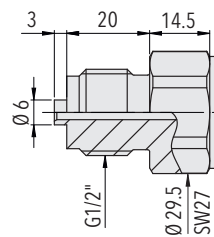

838X.XX.XX11.XX.XX.XX

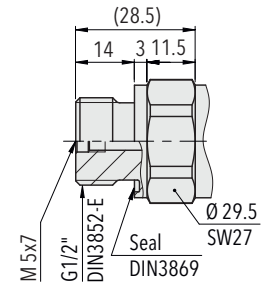

838X.XX.XX41.XX.XX.XX

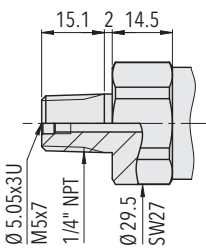

838X.XX.XX30.XX.XX.XX

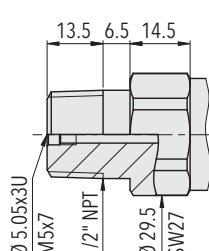

838X.XX.XX51.XX.XX.XX

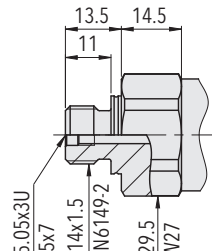

838X.XX.XX31.XX.XX.XX

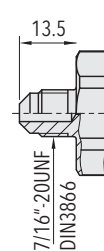

838X.XX.XX18.XX.XX.XX

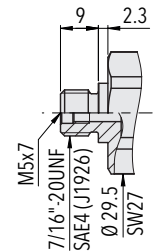

838X.XX.XX42.XX.XX.XX

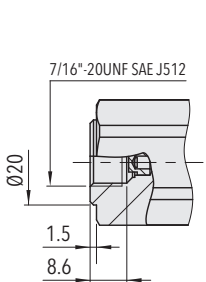

838X.XX.XX24.XX.XX.XX

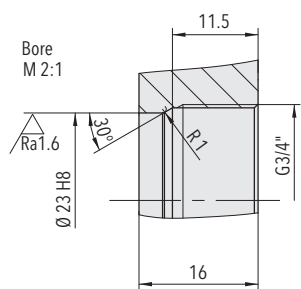

8380.XX.XX52.XX.XX.XX

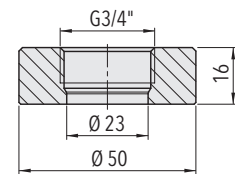
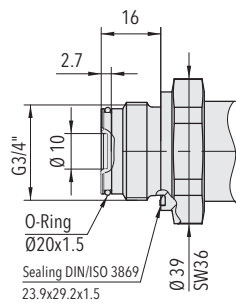

Welding flange for G3/4" frontal membrane (1.4301)
Ordering No. C27805

Operating menu

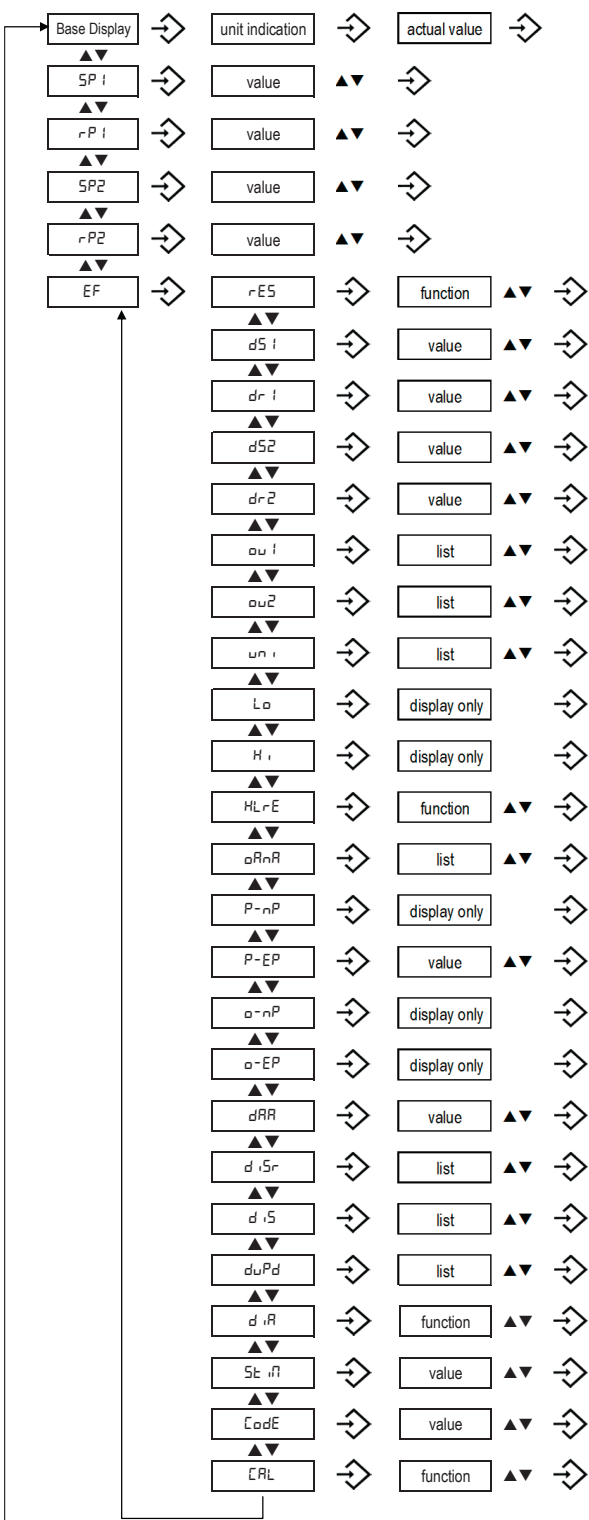

Description	Value range
Switch point SP1 (Hysteresis) or Window high FH1	SP1 > rP1, FH1 > FL1 Hysteresis ≥ 1 % FS
Reset point rP1 (Hysteresis) or Window low FL1	rP1 < SP1, FL1 < FH1 Hysteresis ≥ 1 % FS
Switch point SP2 (Hysteresis) or Window high FH2	SP2 > rP2, FH2 > FL2 Hysteresis ≥ 1 % FS
Reset point rP2 (Hysteresis) or Window low FL2	rP2 < SP2, FL2 < FH2 Hysteresis ≥ 1 % FS
Reset to factory settings	
Switching delay time for SP1/FH1	0.01 ... 99.99s
Switching delay time for rP1/FL1	0.01 ... 99.99s
Switching delay time for SP2/FH2	0.01 ... 99.99s
Switching delay time for rP2/FL2	0.01 ... 99.99s
Function switching output 1	Hysteresis NO (Hno), Hysteresis NC (Hnc) Window NO (Fno), Window NC (Fnc)
Function switching output 2	Hysteresis NO (Hno), Hysteresis NC (Hnc) Window NO (Fno), Window NC (Fnc)
Pressure unit	bar/MPa/kPa/psi/m WC/mm WC
Lowest measured pressure	
Highest measured pressure	
Reset highest and lowest pressure value	
Analogue output type	I, U, off
Pressure zero point	
Pressure end point	50 % ... 100 % FS
Analogue output zero point	
Analogue output end point	
Damping analogue output rise time 10 ... 90 % nominal pressure	0.01 ... 3.00 s
Display rotate	no, yes (180°)
Display mode	actual, highest, lowest, off, act. - 1 decimal, act. - 2 dec., act. - 3 dec.
Display update rate	1, 2, 5, 20 Hz
Diagnostic mode	
Sampling time for logger	0.1 ... 999.9 s, off (0)
Access code	4-digit code
Factory use	

H73320g Trafag AG 11/2018

We reserve the right to make alterations as technical progress may warrant.

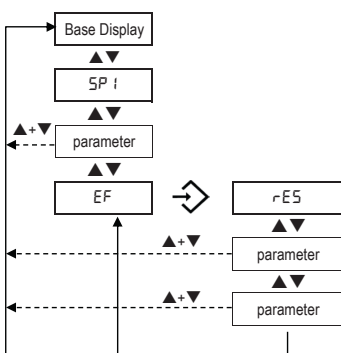

By pressing ▲+▼ simultaneously the menu will return to the base display or automatically after ca. 60 s without operation.

pw* When performing a parameter change by pressing ▲ or ▼ and if an access code has been defined, it has to be entered digit by digit.

After confirming the new parameter value, the menu item of the changed parameter will be displayed.

