

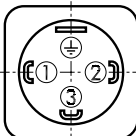
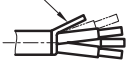
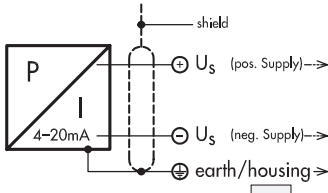

**Elektrischer Anschluss / Raccordement électrique / Electrical connection**

Schutzart/ Protection	IP65 <sup>2)</sup>		IP69K
Ausführung Exécution Execution	EN175301-803-A (DIN 43650-A) <b>04</b>		Cable* <b>78</b>
Ausgangssignal Signal de sortie Output			Abschirmung écran / shield 
 <b>8264.XX.XXXX.XX.19</b>	standard	with accessory <b>92</b>	brown  black yellow/green
	2 	1 	

<sup>2)</sup> nur mit vorschriftsmässig montierter Kabeldose gültig  
valable seulement avec fiche femelle montée selon instructions  
provided female connector is mounted according to instructions

\* Entlüftung über das Kabelende/ ventilation par extrémité du câble/  
ventilation via cable end

Output	Load resistance	$I_{SUPPLY}$	$U_{SUPPLY}$	<b>8264.XX.XXXX.XX.19</b>
4 ... 20 mA	$(U_{Supply} - 9V) / 20mA$		9 ... 32 VDC	

**Anziehdrehmoment Druckanschluss/ Couple de serrage raccord de pression / Torque moment pressure connection**

<b>8264.XX.XX10.XX...</b>	G1/4":	32 ... 40 Nm
<b>8264.XX.XX18.XX...</b>	G1/8":	16 ... 20 Nm
<b>8264.XX.XX17.XX...</b>	M10x1.0:	16 ... 20 Nm
<b>8264.XX.XXXX.XX.XX.41</b> ...	Flange:	4.5... 6 Nm

**Umgebungstemperatur / Température ambiante / Ambient temperature**

-40°C... +100°C (-40°F...+210°F)

**Lagertemperatur / Température de stockage / Storage temperature**

-40°C... +100°C (-40°F...+210°F)

# Überdruck / Surpression / Overpressure

Nenndruck pression nominal nominal pressure		Überdruck Surpression Over pressure	
[bar]	[psi]	[bar]	[psi]
0 ... 2.5	0 ... 30	5	70
0 ... 4.0	0 ... 50	8	115
0 ... 6.0	0 ... 100	12	170
0 ... 10	0 ... 150	20	290
0 ... 16	0 ... 250	32	464
0 ... 25	0 ... 400	50	725
0 ... 40	0 ... 500	80	1160
0 ... 60	0 ... 1000	120	1740
0 ... 100	0 ... 1500	200	2900
0 ... 160 <sup>1)</sup>	0 ... 2000	320	4640
0 ... 250 <sup>1)</sup>	0 ... 3000	500	7250

<sup>1)</sup> Nur Druckanschluss G1/4" / seulement raccord de pression G1/4" / Only pressure connection G1/4"

## Massbilder / Cotes d'encombrement / Dimensions

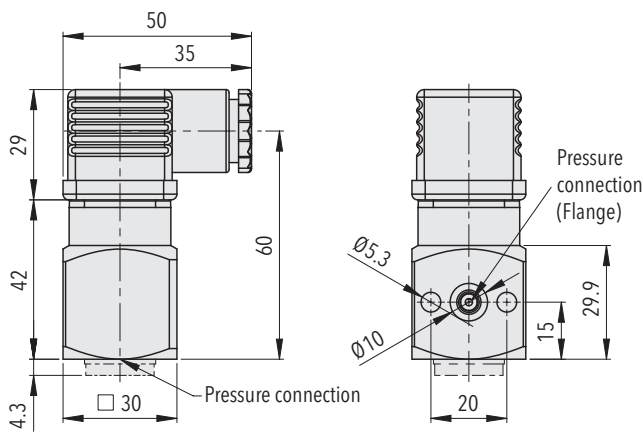

8264.XX.XXXX.04.XX.58

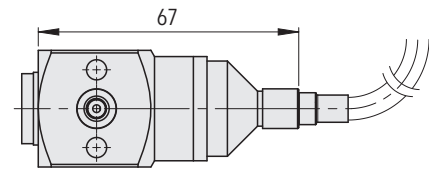

8264.XX.XXXX.78.XX.XX

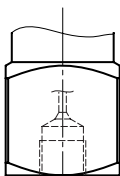

8264.XX.XX10.XX.XX (G 1/4"x12)  
8264.XX.XX18.XX.XX (G 1/8"x10)  
8264.XX.XX17.XX.XX (M10x1.0x10)

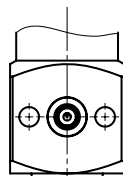

8264.XX.XXXX.XX.XX.41  
(Flange)

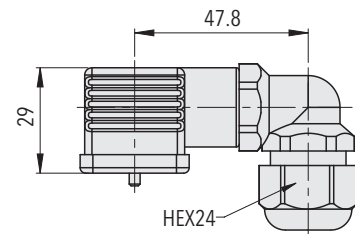

Kabelmontage/Montage du câble/Cable mounting

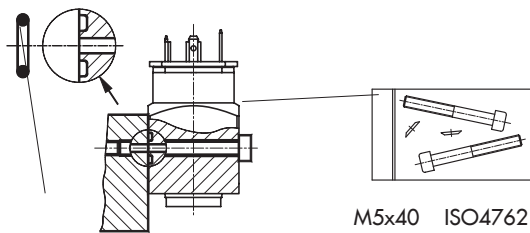

O-Ring:  $\varnothing$  6.75x1.78 (NBR 90 Shore)

8264.XX.XXXX.XX.XX.41.XX... 8264.XX.XXXX.XX.XX.V3.XX...

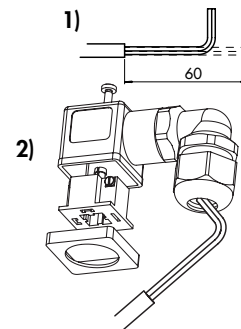

8264.XX.XXXX.04.XX.55