

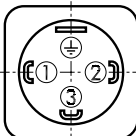
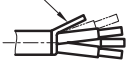
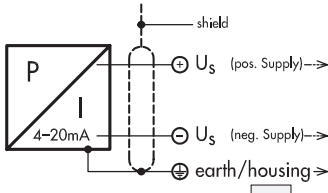

**Elektrischer Anschluss / Raccordement électrique / Electrical connection**

|  |  |  |  |
|--|--|--|--|
| Schutzart/ Protection  | IP65 <sup>2)</sup>   |  | IP69K  |
| Ausführung<br>Exécution<br>Execution   | EN175301-803-A<br>(DIN 43650-A)<br><b>04</b>   |  | Cable*<br><b>78</b>  |
| Ausgangssignal<br>Signal de sortie<br>Output   |      |  | Abschirmung<br>écran / shield<br> |
| <br><b>8264.XX.XXXX.XX.19</b> | standard   | with accessory <b>92</b>   |  |
|  | 2<br> | 1<br> | brown<br><br>black<br>yellow/green   |

<sup>2)</sup> nur mit vorschriftsmässig montierter Kabeldose gültig  
valable seulement avec fiche femelle montée selon instructions  
provided female connector is mounted according to instructions

\* Entlüftung über das Kabelende/ ventilation par extrémité du câble/  
ventilation via cable end

|             |                            |              |              |                           |
|-------------|----------------------------|--------------|--------------|---------------------------|
| Output      | Load resistance            | $I_{SUPPLY}$ | $U_{SUPPLY}$ | <b>8264.XX.XXXX.XX.19</b> |
| 4 ... 20 mA | $(U_{Supply} - 9V) / 20mA$ |              | 9 ... 32 VDC |                           |

**Anziehdrehmoment Druckanschluss/ Couple de serrage raccord de pression / Torque moment pressure connection**

|                                  |          |              |
|----------------------------------|----------|--------------|
| <b>8264.XX.XX10.XX...</b>        | G1/4":   | 32 ... 40 Nm |
| <b>8264.XX.XX18.XX...</b>        | G1/8":   | 16 ... 20 Nm |
| <b>8264.XX.XX17.XX...</b>        | M10x1.0: | 16 ... 20 Nm |
| <b>8264.XX.XXXX.XX.XX.41</b> ... | Flange:  | 4.5... 6 Nm  |

**Betriebstemperatur / Température de service / Operating temperature**

-40°C... +100°C (-40°F...+210°F)

**Lagertemperatur / Température de stockage / Storage temperature**

-40°C... +100°C (-40°F...+210°F)

# Überdruck / Surpression / Overpressure

| Nenndruck<br>pression nominal<br>nominal pressure |            | Überdruck<br>Surpression<br>Over pressure |       |
|---|------------|---|-------|
| [bar]   | [psi]      | [bar]                                     | [psi] |
| 0 ... 2.5   | 0 ... 30   | 5   | 70    |
| 0 ... 4.0   | 0 ... 50   | 8   | 115   |
| 0 ... 6.0   | 0 ... 100  | 12  | 170   |
| 0 ... 10  | 0 ... 150  | 20  | 290   |
| 0 ... 16  | 0 ... 250  | 32  | 464   |
| 0 ... 25  | 0 ... 400  | 50  | 725   |
| 0 ... 40  | 0 ... 500  | 80  | 1160  |
| 0 ... 60  | 0 ... 1000 | 120                                       | 1740  |
| 0 ... 100   | 0 ... 1500 | 200                                       | 2900  |
| 0 ... 160 <sup>1)</sup>                           | 0 ... 2000 | 320                                       | 4640  |
| 0 ... 250 <sup>1)</sup>                           | 0 ... 3000 | 500                                       | 7250  |

<sup>1)</sup>Nur Druckanschluss G1/4" / seulement raccord de pression G1/4" / Only pressure connection G1/4"

## Massbilder / Cotes d'encombrement / Dimensions

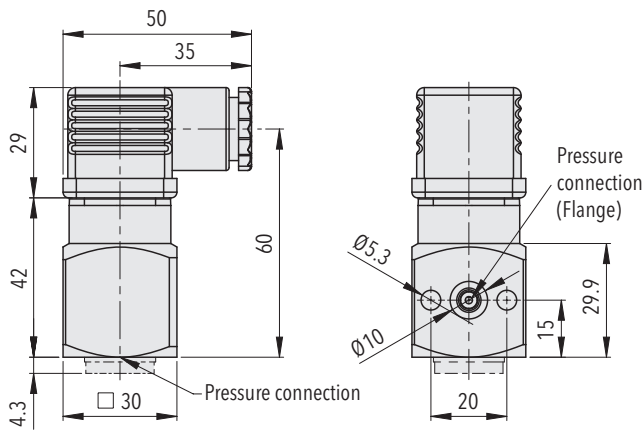

8264.XX.XXXX.04.XX.58

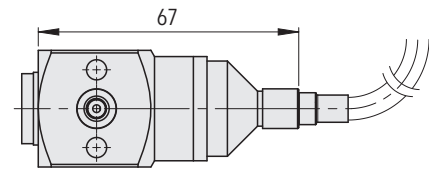

8264.XX.XXXX.78.XX.XX

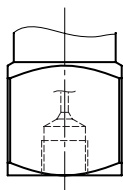

8264.XX.XX10.XX.XX (G 1/4"x12)  
8264.XX.XX18.XX.XX (G 1/8"x10)  
8264.XX.XX17.XX.XX (M10x1.0x10)

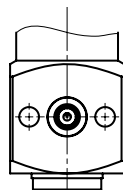

8264.XX.XXXX.XX.XX.41  
(Flange)

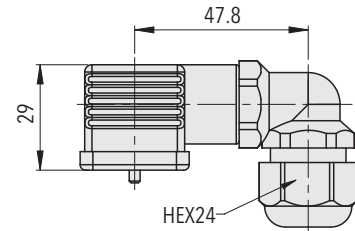

Kabelmontage/Montage du câble/Cable mounting

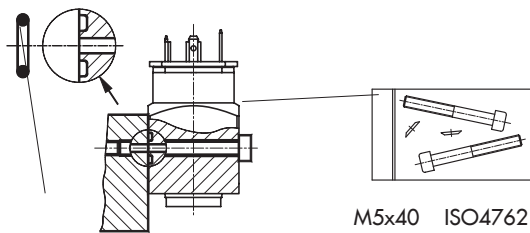

O-Ring: ø 6.75x1.78 (NBR 90 Shore)

8264.XX.XXXX.XX.XX.41.XX... 8264.XX.XXXX.XX.XX.V3.XX...

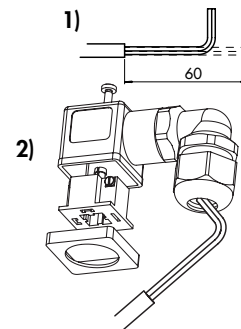

8264.XX.XXXX.04.XX.55