

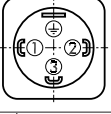

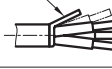



Elektrischer Anschluss / Raccordement électrique / Electrical connection

Schutzart/ Protection	IP65 ²⁾	IP69K	IP69K ²⁾	IP67 ²⁾
Ausführung Connexion électr. Electrical connection	EN175301-803-A (DIN43650-A) 04/05 	Cable* 78 Abschirmung écran / shield 	DIN 72585* Code 1 25 	MIL-C 26482 02 
Ausgangssignal Signal de sortie Output	 829X.XX.XXXX.XX.19	standard 2 1  	with accessory 92 1 2  	blue: not conn. brown - - - A B E
 829X.XX.XXXX.XX.23			blue: not conn. brown black yellow/green 1 2 4 3	

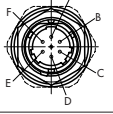
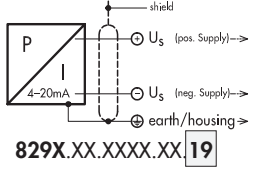
*Entlüftung über das Kabelende/ Ventilation par extrémité du câble/ Ventilation via cable end

²⁾ Ausführung/ Connexion électrique/ Electrical connection 04/05/25/02: nur mit vorschriftsmässig montierter Kabeldose gültig/ valable seulement avec fiche femelle montée selon instructions/ provided female connector is mounted according to instructions

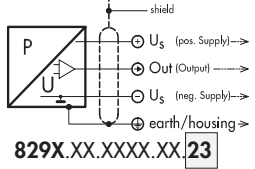
Output	Load resistance	I _{SUPPLY}	U _{SUPPLY}	
4 ... 20 mA	(U _{Supply} - 9V)/20mA		9 ... 32 VDC	829X.XX.XXXX.XX.19..
0.5 ... 4.5 VDC	≥15.0 kΩ	≤12 mA	5 VDC ±0.25 VDC ratiometrisch/ ratiométrique/ ratiometric	829X.XX.XXXX.XX.23..

Anziehdrehmoment Druckanschluss/ Couple de serrage raccord de pression / Torque moment pressure connection

829X.XX.XX17.XX...	G 1/4": 25 Nm ± 5Nm
829X.XX.XX19.XX...	R 1/4": anwendungsspezifisch/dépend de l'application/depending on application
829X.XX.XX11.XX...	G 1/2": 25 Nm ± 5Nm (Manometer/ manomètre/ manometer)
829X.XX.XX30.XX...	NPT 1/4": 25 Nm ± 5Nm
829X.XX.XX51.XX...	NPT 1/2": 25 Nm ± 5Nm
829X.XX.XX28.XX...	M14x1.5 (Kegeldichtung/ Joint conique/ Conical seal: 58°): 30 Nm ± 5Nm
829X.XX.XX29.XX...	M18x1.5 (Kegeldichtung/ Joint conique/ Conical seal: 58°): 30 Nm ± 5Nm

Betriebstemperatur / Température de service / Operating temperature

-40°C ... +125°C (-40°F ... +260°F)

Lagertemperatur / Température de stockage / Storage temperature

-40°C ... +125°C (-40°F ... +260°F)

Überdruck / Surpression / Overpressure

Nenndruck Pression nominal Nominal pressure		Überdruck Surpression Overpressure	
[bar]	[psi]	[bar]	[psi]
0 ... 2.5	0 ... 30	5	70
0 ... 4.0	0 ... 50	8	115
0 ... 6.0	0 ... 100	12	170
0 ... 10	0 ... 150	20	290
0 ... 16	0 ... 250	32	464
0 ... 25	0 ... 400	50	725
0 ... 40	0 ... 500	80	1160
0 ... 60	0 ... 1000	120	1740
0 ... 100	0 ... 1500	200	2900

Nenndruck Pression nominal Nominal pressure		Überdruck Surpression Overpressure	
[bar]	[psi]	[bar]	[psi]
0 ... 160	0 ... 2000	320	4640
0 ... 250	0 ... 3000	500	7250
0 ... 400	0 ... 5000	800	11600
0 ... 600	0 ... 7500	1000	14500
0 ... 1000	0 ... 10000	1800	26100
0 ... 1600	0 ... 20000	3000	43500
0 ... 2000	0 ... 30000	3000	43500
0 ... 2500	0 ... 35000	3000	43500

Massbilder / Cotes d'encombrement / Dimensions

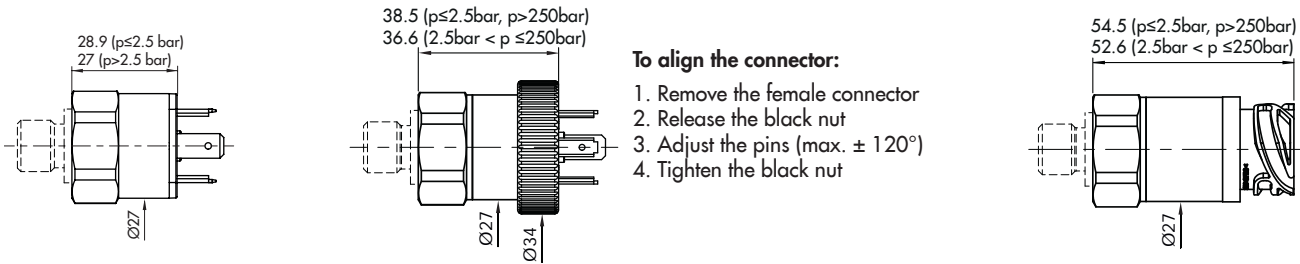

829X.XX.XX.XX.04.XX.XX

829X.XX.XX.XX.05.XX.XX

829X.XX.XXXX.25.XX.XX

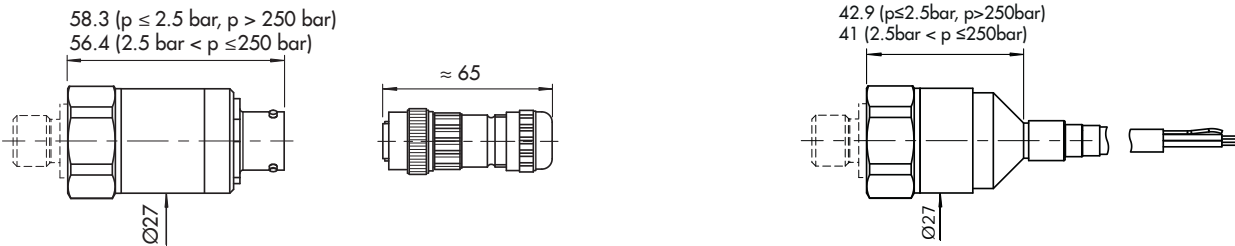

829X.XX.XXXX.02.XX.XX

829X.XX.XXXX.02.XX.32

829X.XX.XXXX.78.XX.XX

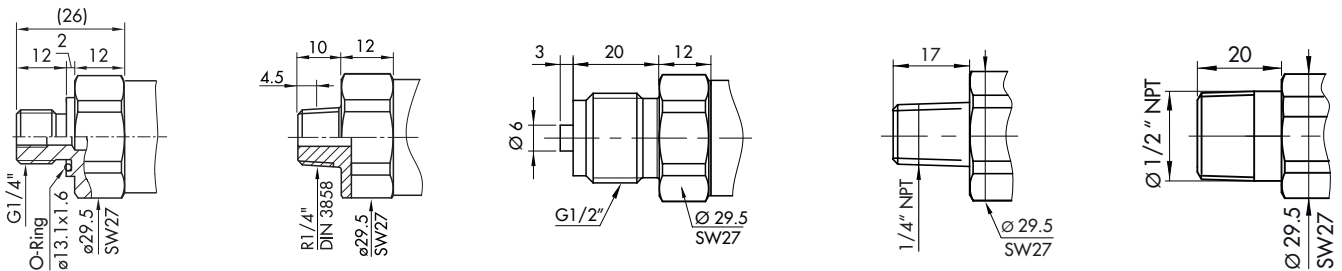

829X.XX.XX.17.XX.XX

829X.XX.XX.19.04.XX

829X.XX.XX.11.XX.XX.XX

829X.XX.XX.30.XX.XX

829X.XX.XX.51.XX.XX

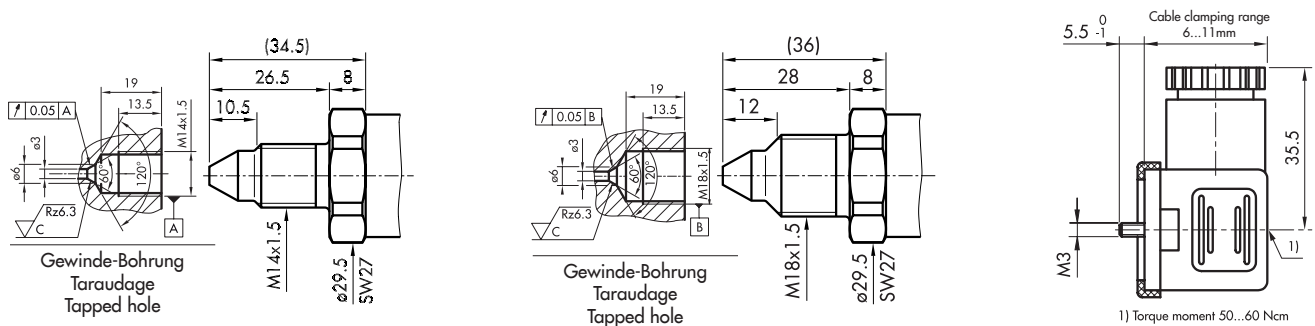

829X.XX.XX.28.XX.XX

829X.XX.XX.29.XX.XX

829X.XX.XXXX.XX.XX.58